



G6

3-Axis Stabilized Handheld Gimbal

Guilin Feiyu Technology Incorporated Company

User Manual EN V1.5

1. Product Overview

* The showing sports camera is not included in the package

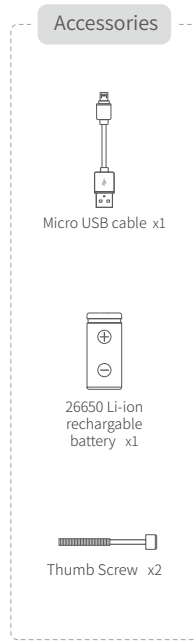
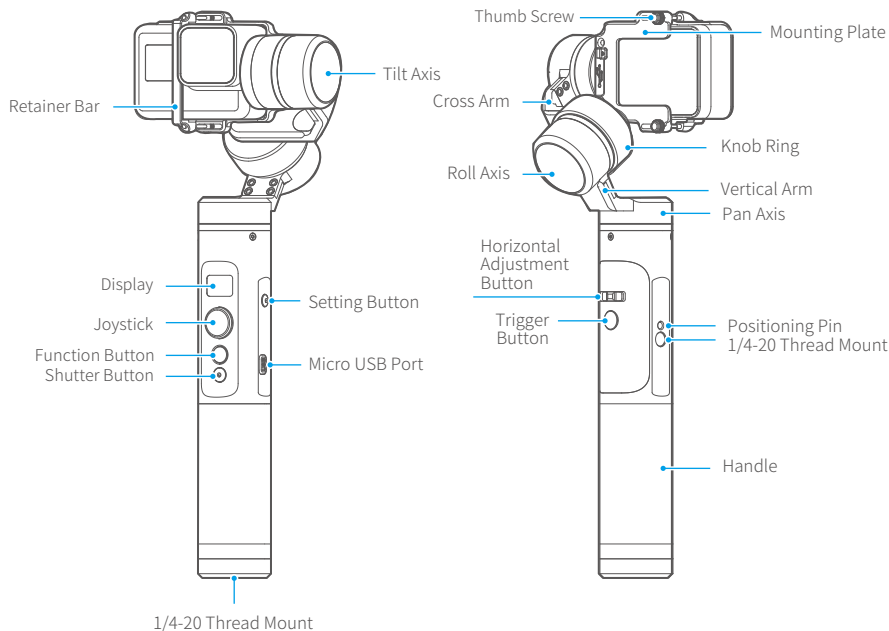

2. Quick Start Guide

1 Install Battery

Please fully charge the battery before power on the gimbal for the first time.

Remove the bottom cap, insert a 26650 battery and then tighten the cap.

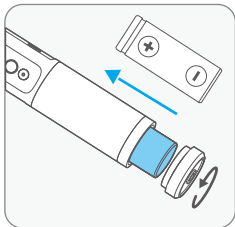

2 Put the camera on

Please mount the camera before power on the gimbal.
When not in use, turn off the gimbal and then remove the camera.

Take the GoPro HERO 5 camera for example.

Put the camera on mounting plate, then tighten the camera with retainer bar and screw.

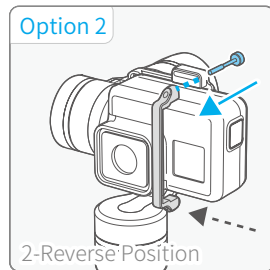
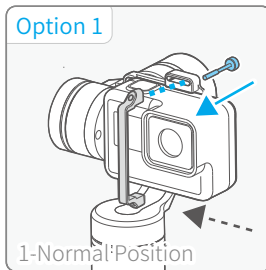

* It is suggested to turn on the camera before installation for normal position.

Put the RX0 camera on

To work with RX0 camera, please change RX0 camera adapter kit.

*RX0 camera adapter kit is optional.

Replacement steps

- (1) Loose and take down the original fixed plate of the gimbal
- (2) Install RX0 adapter plate and tighten the screw ① ②
- (3) Insert the set screw ③ of the camera from the bottom of RX0 adapter plate
- (4) Place the camera and tighten the set screw

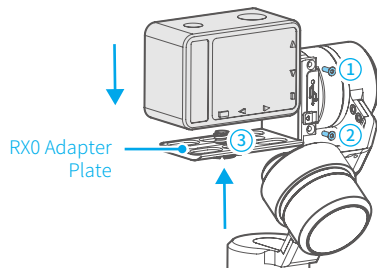

3 Balance the Gimbal (Before power on)

If camera tilts to the left, **loosen the knob ring**, **pull cross arm out to the right** until camera is horizontal.

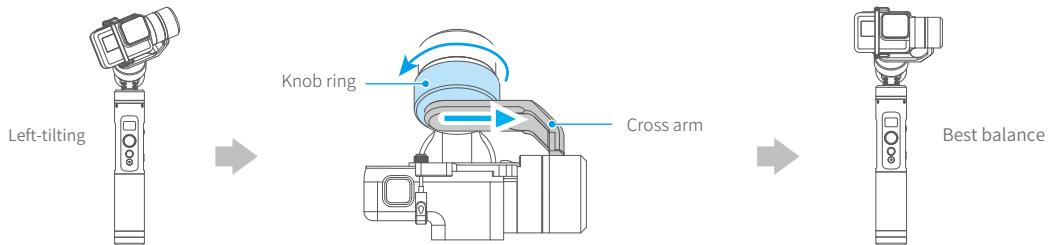

If camera tilts to the right, **loosen the knob ring**, **push cross arm in to the left** until camera is horizontal.

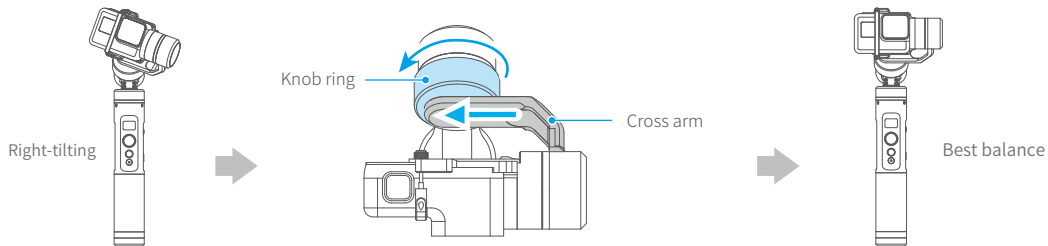

4 Power on / off

Power on / off: Long press the function button, the display will show **Fy** and release it when you hear the beep tone.

3. Charging

Charging for Gimbal

Charging with Micro USB cable



Micro USB Port



Micro USB Cable



USB Port



(Equipped by user)

Output
5V / 2A

Charging icons on display screen

Charging



Charging
Completes

Charging for Camera

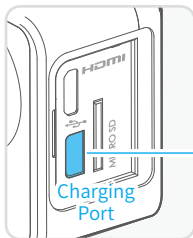

Charging
Port

Camera

Connect the camera with the gimbal via charging cable, the camera can be charged when gimbal is powered on.

Camera power-
supply port

Micro Port

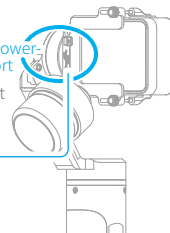

G6

4. Functions

Buttons

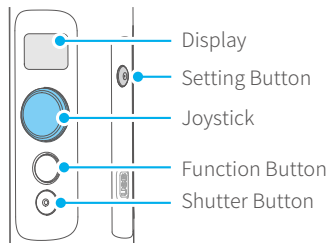

Joystick

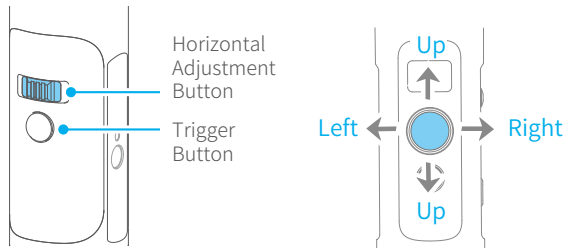

Modes

Panning Mode (Default mode)

The roll and tilt direction are fixed, and the camera moves according to the left-right movements of the user's hand.

Follow Mode

The roll direction is fixed, and the camera moves according to the left-right movements, up-down movements of the user's hand.

Lock Mode

The orientation of the camera is fixed.

Reset

Return to panning mode, three axes return to default position.

Display

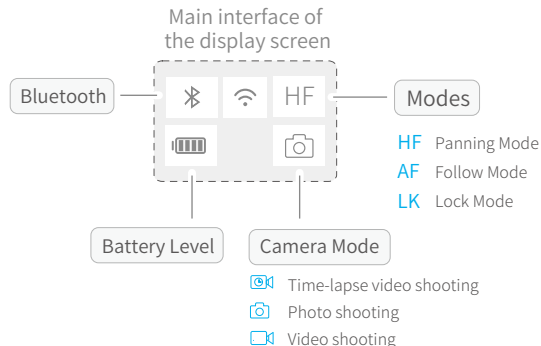

Operation and explanation of some buttons

Function Button	Function	Explanation
Single tap	Panning Mode / Lock Mode	Single tap to switch between panning mode and lock mode
Double tap	Follow mode	Under follow mode, control the pan axis by moving the joystick to the left or right
Triple tap	Rotate 180° in horizontal	Make the camera lens rotate 180 °
Quadruple tap	Auto-rotation Mode	Enter auto-rotation mode Please refer to the chapter "Auto-rotation Mode" in page 8-9
Five tap	Initialization	Enter initialization Please refer to the chapter "Gimbal Initialization" in page 12
Trigger Button	Function	Explanation
Press and hold	Quickly Follow	In the panning mode or follow mode, press and hold the trigger button to enter quickly follow, release it to return previous mode
Double tap	Reset	Return to panning mode, tilt,roll and pan axis return to initial level
Setting Button	Function	Explanation
Long press	Swith the interface for camera parameters	Long press in the main interface can swith to the interface for camera parameters
Single tap	Swith camera modes / main interface	Single tap in the main interface can switch to camera modes (camera needs to be connected) Single tap in the interface for camera parameters can switch to the main interface

Note: The firmware upgrade may occur manual operation function and the actual product features do not match. Please find the latest manual on the official website.

Display Description

Display Icons	Mode / Status
HF	Panning mode
AF	Follow mode
LK	Lock mode
SET WIFI VIA APP	Prompt for users to open the App settings in order to connect via WiFi
	Bluetooth is connected
	Bluetooth is not connected
	Camera is not connected ^①
	Camera photo shooting
	Camera video shooting
	Camera time-lapse video shooting
	WiFi is connected
	WiFi is not connected
	Battery level

^① Please refer to the chapter "Connecting to camera" in page 11

Setting Parameters

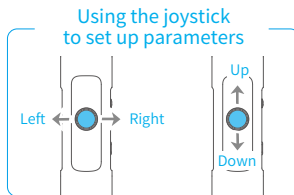
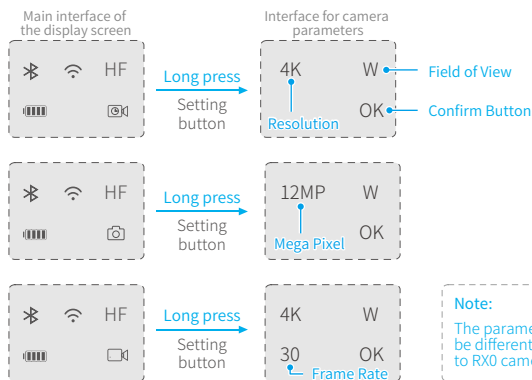

Setting Parameters:

Joystick	Explanation
Move to left / right	Switch content
Move to up / down	Setting parameters
Move to right until "OK" displays	Move to right again for confirmation

Shutter Button Operation

After connecting the gimbal to camera ^① via Feiyu On App, single tap the button can control the camera for shooting.

■ Horizontal Angle Control

You can control the horizon angle via the horizontal adjustment button while in panning mode, follow mode or lock mode.

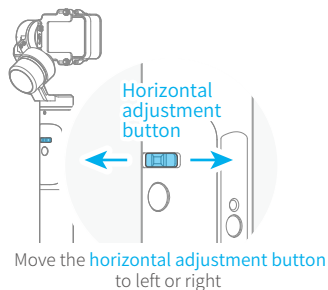

■ Auto-rotation Mode

The G6 gimbal can easily create constant speed movements in the auto-rotation mode. This mode can be used for recording both regular video and motion timelapse photography. For better performance, attach gimbal to the FeiyuTech tripod, or other tripod, to keep it completely still.

Set rotation speed in Feiyu ON App

Connect to the Feiyu ON App and select desired speed from the auto-rotation mode rate option in the settings menu.

G6 Rotation Speed

12s/turn	18s/turn	24s/turn	30s/turn	1min/turn	2min/turn	4min/turn	8min/turn	15min/turn	30min/turn	1h/turn (Default)	4h/turn	8h/turn
----------	----------	----------	----------	-----------	-----------	-----------	-----------	------------	------------	----------------------	---------	---------

Note: Both the pan and tilt directions can be rotated.

■ Manual Lock

Camera can be manually positioned while in panning mode, follow mode or lock mode. Both the pan axis and tilt axis can be manually set up.

Manually move camera to desired position, and hold for half a second. New tilt and/or pan positions are automatically saved.

Take the tilt axis setting for example:

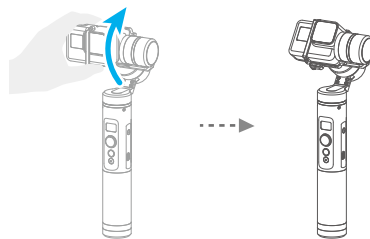

(1) Enter auto-rotation mode

Enter auto-rotation mode by quadruple tapping the function button.

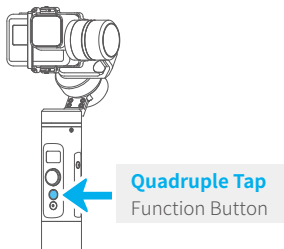

(2) Set rotation start position

Record the first position (rotation start position) by manually moving camera to desired position. Hold in position for half a second. Single tap the function button to record rotation start position.

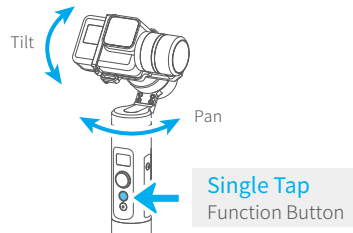

(3) Set rotation end position

Record the second position (rotation end position) by manually moving camera to desired position. Hold in position for half a second. Single tap the function button to record rotation end position.

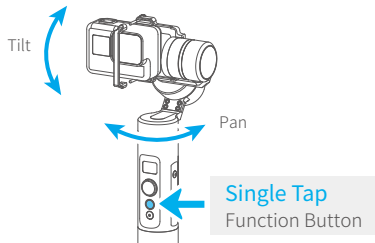

(4) Start auto rotation movements

The gimbal automatically restores to the start position, while the tilt axis and pan axis start rotating at a constant speed according to pre-set speed to end position, repeat step (2) (3) to start again.

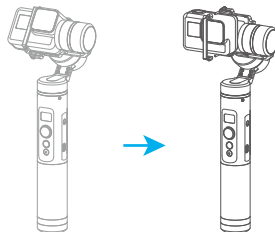

Exit → **Double tap** Trigger button → Exit the auto-rotation mode and reset

5. Download and connect App

1 Download and install “Feiyu ON” App

Please download Feiyu ON at your smartphone app store or can the QR code below.

* Requires iOS 9.0 or later, Android 6.0 or later.



iOS Version



Android Version

2 Connecting App

Turn on the Bluetooth and run the App on smartphone, follow on the instructions to connect smartphone to gimbal via bluetooth.



Feiyu ON

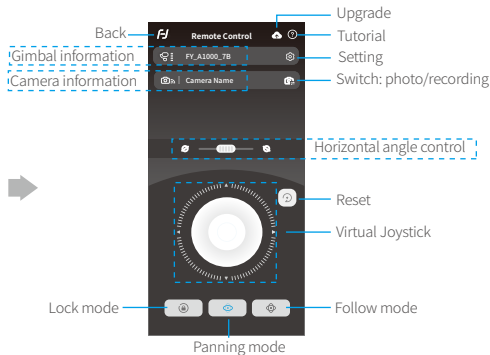
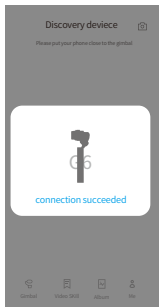

6. Connecting to Camera

G6 gimbal can connect to the camera by Feiyu ON App.

Operations available after connecting to the camera:

Button	Operation	Function
Setting Button	Single tap	Single tap in the main interface of the gimbal display can switch to the camera modes
Shutter Button	Single tap	On the main interface of the gimbal display, single tap for shooting / start shooting / stop shooting

Steps of connecting to camera:

- (1) Turn on your sports camera's WiFi (2.4GHz)
- (2) Successively select "Settings" -- "Parameters Settings" -- "WiFi Settings" on Feiyu ON App
- (3) Select camera model
- (4) Select your camera connection name and enter the correct connection password of your camera
- (5) Waiting for connecting
- (6) Connect successfully

If icon  appears on the display screen, it means the gimbal failed to connect to the camera, try to restart gimbal or camera, or reconnect according to above steps

If the WiFi is not connected for a long time, please restart the camera's WiFi.

7. Firmware Upgrade

Upgrade the firmware through the Feiyu ON App.

- (1) Click the icon
- (2) Select upgrade type.
- (3) Follow the prompts to upgrade the firmware.

Upgrade type introductions:

Gimbal update: Repair / update or newly add gimbal control / function / parameter and etc.

Keyboard update: Repair / update or newly add button/touch screen/interaction functions, update more compatibility cameras which can be controlled through WIFI, repair few bugs about camera control through WIFI, and etc.

Bluetooth firmware update: Repair / update or newly add Bluetooth functions, update more compatibility cameras, and etc.

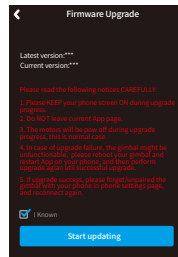

8. Gimbal Initialization

You can initialize your gimbal when:

- (1) When camera is not level
- (2) If not used for a long period of time
- (3) In case of extreme temperature variations

Adjusting Steps:

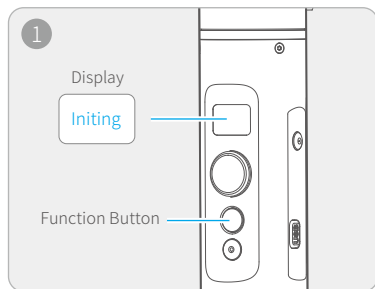

Tap the function button for 5 consecutive times and hear the "beep" sound, and the motor will stop working and "Initing" shows up.

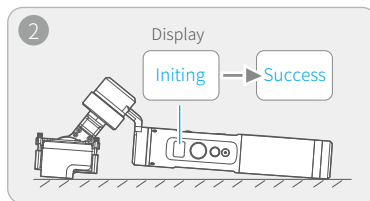

Place the gimbal on the table unmoved, and the gimbal automatically detect whether or not it is placed on a static flat surface, and then its initializing will start automatically showing "Initing" on the display, and "Success" will be displayed after the initializing has been successfully completed.

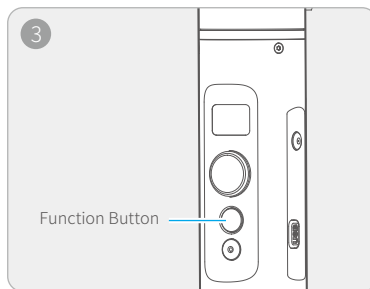

After the initialization is done, single tap the function button to wake up and return to the main interface.

Note: if the initialization is not successful for a long time, long press the function button to turn off the gimbal, restart it and then initialize.

9. Technical Specifications

(Unit:mm)

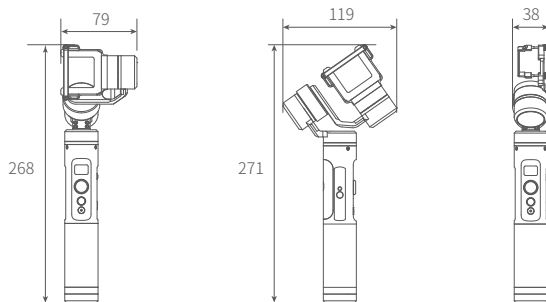

Max. Tilting Range	360°
Max. Rolling Range	320°
Max. Panning Range	360°
Tilting Speed	Min: 2°/s - Max: 75°/s
Panning Speed	Min: 3°/s - Max: 150°/s
Operation Time	12 Hours
Adaption Camera	GoPro HERO6 / HERO5 and other cameras with the same size, replace the optional RX0 adapter plate to be compatible with RX0 camera
Weight	336g (Not including battery and camera)

DISCLAIMER

Prohibit any user for any illegal purpose. Users will be responsible for all behaviors of purchase and use products.

The Company assumes no liability for any risks related to or resulting from the debug and use of this product (including the direct, indirect or third-party losses).

For any unknown sources of using, we will not be at any services.

The updating and changes of product firmware and program may cause changes in function descriptions in this user manual, please read the instructions carefully before upgrading the firmware and use the corresponding user manual.

You can get the latest user manual from the official website: www.feiyu-tech.com

FeiyuTech reserves the right to amend this manual and the terms and conditions of use the gimbal at any time.

Attention

- Please correctly assemble the gimbal in accordance with the diagram.
- Please install the camera before powering on the gimbal.
- When the gimbal is not in use or placed on the table, please ensure it is powered off.
- Remove the battery when not in use for a long time.

Guilin Feiyu Technology Incorporated Company

Website: www.feiyu-tech.com

E-mail: service@feiyu-tech.com

Tel: +86(0)773 2320865

Due to software and hardware improvements, your actual product might differ from the descriptions and pictures in this user manual. You can get the latest user manual from the official website.

For more information, please visit our official website

